

SensorDIM[®] LED Driver

Model: HE1025-1

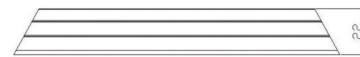
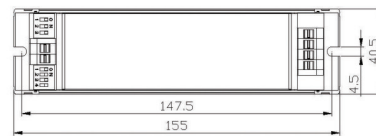
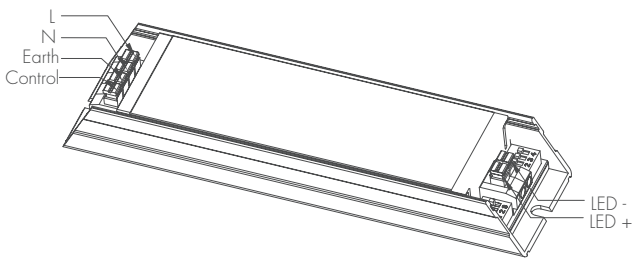

	1	2	3	Current
I	●	●	●	700mA
II	○	●	●	600mA
III	○	○	●	550mA
IV	●	●	○	500mA
V	○	○	●	450mA
VI	○	●	○	400mA
VII	●	○	○	350mA
VIII	○	○	○	250mA

LED current selection

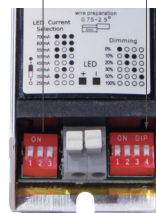

	1	2	3	4	
I	●	○	○	○	0%
II	○	●	○	○	10%
III	○	○	●	○	20%
IV	○	○	○	●	30%
V	○	○	○	●	50%
VI	○	○	○	○	100%

Dimming level set-up

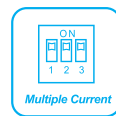
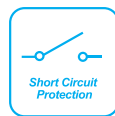

This SensorDIM LED driver is specially designed to work with sensors to achieve dimming function, when receiving the signal from sensors, the driver works on full power, when the signal passes out, the driver works on pre-defined brightness (0%/10%/20%/30%/50%/100%, set up by different combinations of 4 DIP switches), which achieves energy saving.

This driver has a unique benefit of output current selection, 3 DIP switches give customers 8 different current levels to choose (250mA/350mA/400mA/450mA/500mA/550mA/600mA/700mA), which current is higher than the LED rated current, the performance and life-span of LED will be greatly jeopardized.

Aluminum profile filled with silicon rubber for heavy duty task, hostile thermal conditions and tough climate.

HYTRONIK sensorDIM control gear + High voltage output sensors to achieve 2step dimming function

HYTRONIK sensors



HC005S



HC009S



HC009S/ KD



HYTRONIK sensorDIM control gear



2 Steps Dimming Function



- 1 The sensor switches the light at 100% level automatically when a person walks into the room.
- 2 After the hold time, then dim the lamp to a pre-defined dimming level when the person leaves the detection area.

The dimming level can be pre-selected by DIP switches on sensorDIM[®] control

Note: In this application, light never turns off even when the natural light is over the selected threshold.

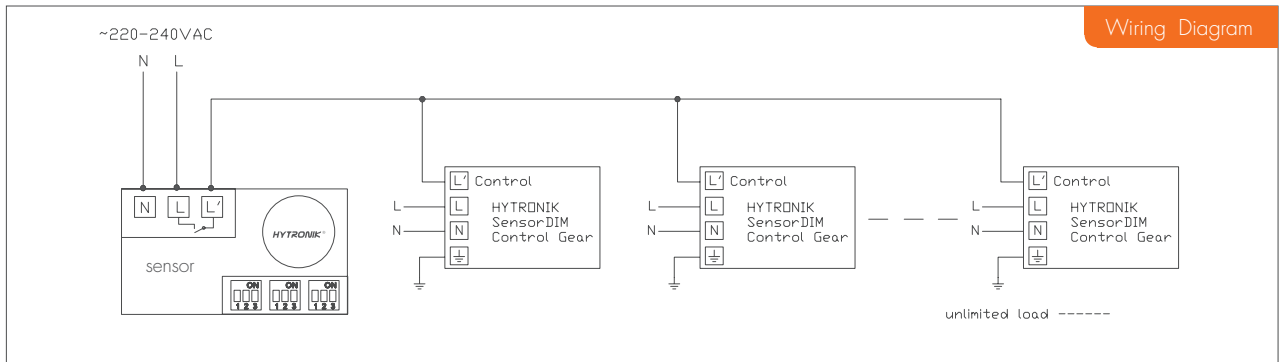

This is a multiple function driver, can also be used for the following purpose:

1. Use an ordinary switch to change the light between 100% and dimmed level. (connect "the L' control" to the switch).
2. Use as multiple current non-dimmable driver. (connect L to L').
3. Use as multiple wattage driver for the same fitting by reducing the current. (connect L to L').

Technical parameters:

Number	Item	Technical data
1	Mains voltage	220~240VAC
2	Mains frequency	50/60Hz
3	Output power	30W
4	Input current	164~150mA
5	Output voltage(U-out Max.)	68VDC Max.
6	Output current selection	250mA/350mA/400mA/450mA/ 500mA/550mA/600mA/700mA
7	Pre-defined dimming level	0%/10%/20%/30%/50%/100%
8	Empty load power consumption	≤ 1.6W
9	Ta	-20℃ ~ +50℃
10	Short-circuit protection	Short-circuit protection, automatic reset
11	Over-heat protection	Over-heating protection, automatic reset
12	Power factor	≥ 0.9
13	Dielectric strength	Input-output 2250VAC/5mA/1min Input-casing 1800VAC/5mA/1min Output-casing 500VAC/5mA/1min
14	EMC standard	EN55015:2007 version EN61547
15	Safety directive	EN61347-2-13
16	Efficiency	85%(Max.)